

Detroit Speed
Track Bar & Shock Relocation Kit
1967-72 GM Square Body Truck
P/N: 040118DS

The Detroit Speed Track Bar and Shock Relocation Kit is a 100% bolt-on kit and has been designed to improve the cornering and ride quality of your lowered 1967-72 GM C10 truck. The adjustable track bar features cross-axis bushings and is relocated to reduce lateral axle movement. Roll center height is adjustable for fine tuning the handling of your truck. Relocated shock mounts provide proper shock travel and improved control for lowered trucks. Included drop shocks are designed for trucks lowered 4" or more. Hardware is included and all brackets are powder coated black for durability. This kit was designed to work with the factory coil spring frame rails only.



Item #	Description	Quantity
1	Track Bar Assembly	1
2	Track Bar Chassis Bracket Assembly	1
3	Upper Shock Mount, LH & RH	2
4	Lower Shock Mount, LH	1
5	Track Bar Axle Bracket/Lower Shock Mount, RH	1
6	Track Bar Hardware Bag	1
7	Shock Mount Hardware Bag	1
8	Rear Drop Shock with Hardware	2
9	Instructions	1

NOTE: The track bar location allows 3" exhaust to be routed above the track bar on the passenger side. Factory style differential cover is required to provide clearance for both the differential and the exhaust. Oversize aluminum differential covers do not provide required clearance.

IMPORTANT:

All work should be performed by a qualified technician. Please read the complete set of instructions and fully understand all the steps involved before beginning the project. Always make sure to wear the appropriate safety equipment for the job and properly support the vehicle. If you have any questions before, during, or after the installation, feel free to contact Detroit Speed by phone at (704) 662-3272 or by email at tech@detroitsspeed.com.

Hardware Kit Checklist – Detroit Speed Track Bar & Shock Relocation Kit			
Part Number	Description	Quantity	Check
200110	Track Bar Hardware Bag	1	
980136FS	7/16"-20 x 1-3/4" L Hex Head Bolt	4	
950042FS	7/16"-20 x 1-1/4" L Hex Head Bolt	4	
960050FS	7/16"-20 Nylock Nut	8	
970042FS	7/16" SAE Washer	16	
980103FS	M14-2.0 x 80mm Flange Hex Head Bolt	2	
960098FS	M14-2.0 Top Lock Flange Nut	2	
200111	Shock Mount Hardware Bag	1	
980017FS	1/2"-13 x 2-1/4" L Hex Head Bolt	2	
960019FS	1/2"-13 Nylock Nut	2	
970037FS	1/2" SAE Washer	4	
980059FS	3/8"-24 x 1" L Hex Head Bolt	6	
960032FS	3/8"-24 Nylock Nut	6	
970023FS	3/8" SAE Washer	12	

Installation:

1. Remove the bed from the truck. Raise the truck up on jack stands so that the frame is level with the ground. Support the rear axle so the rear brake lines are not in tension.
2. Remove the rear shocks and springs from the truck. Springs are held in place with retainer pieces, set them aside for re-installation later.
3. Place two jack stands under the rear axle tubes and one jack stand under the pinion of the rear axle. Remove the lower shock mount by removing the U-bolts and nuts. Lower the trailing arm from the axle (Figure 1).



Figure 1 – Lower Trailing Arms

4. Remove the upper shock mounts from the cross member by removing the two rivets holding the brackets in place on both sides of the cross member (Figure 2). **NOTE:** DSE recommends cutting the rivet from the top side.

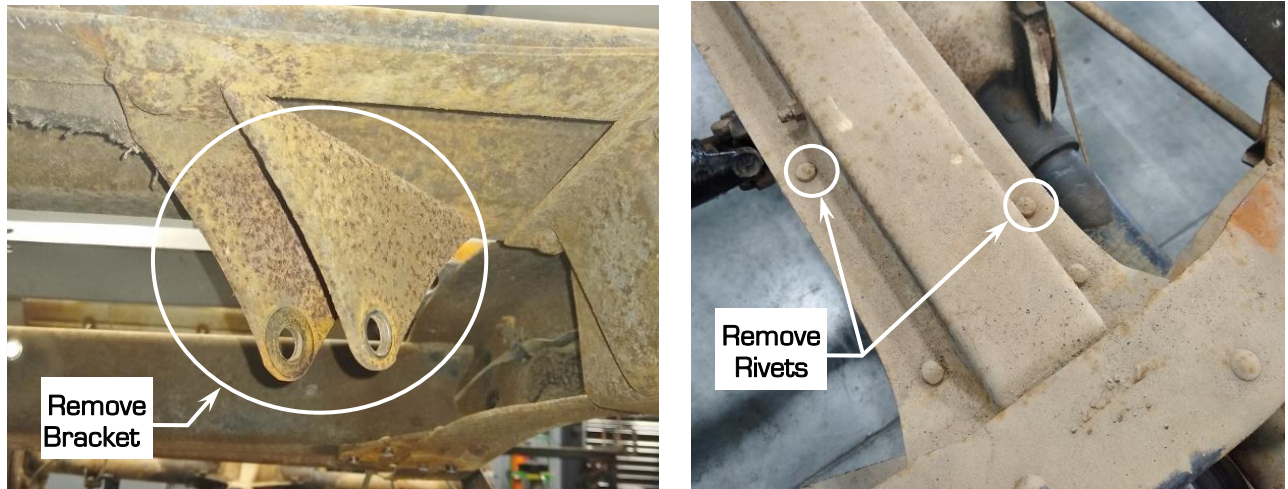

Figure 2 - Remove Rear Axle Bump Stop Bracket

5. Remove the factory track bar from the truck. Remove the factory track bar bracket on the driver's side frame rail by removing the four rivets on the bottom side of the frame rail (Fig. 3).



Figure 3 - Remove Panhard Bar & Bracket

6. Identify the left and right hand upper shock mounts (Figure 4). Position the right hand upper shock mount under the crossmember in front of the rear axle. Place one of the provided 3/8"-24 x 1"L hex head bolts, washers and Nylock nuts through the hole on the backside of the crossmember where the rivet was removed in Step 4.



Figure 4 - Left Hand & Right Hand Upper Shock Mount

7. Clamp the right hand upper shock mount in place and transfer punch the two remaining holes in the mount to the underside of the crossmember (Figure 5).

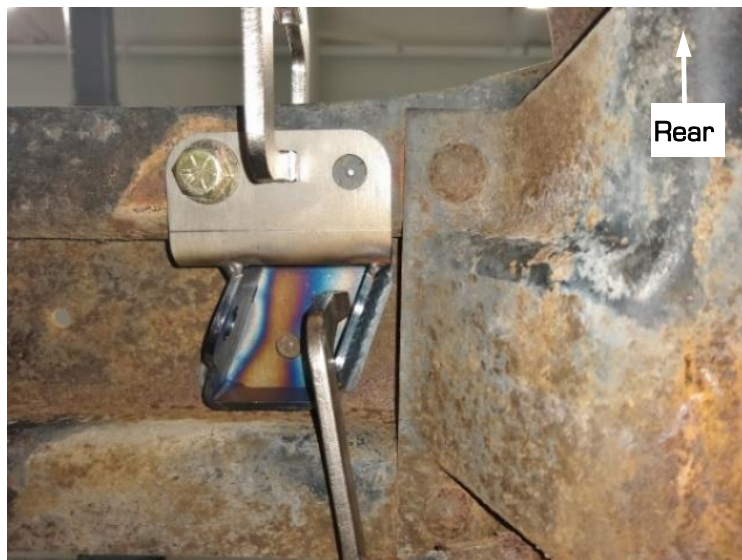

Figure 5 - Transfer Punch Mounting Holes

8. Position the left hand upper shock mount underneath the crossmember. Measure over 1-1/4" from the center of the rivet on the rearward flange of the crossmember (Figure 6). That will be the location of outboard hole on the upper shock mount. Measure over 3" from the center of the rivet, this will be the location of the inboard hole on the upper shock mount. **NOTE:** The two mounting holes on the rearward flange of the crossmember will be on either side of the factory hole left over from removing the rivet in Step 4. The factory upper shock mounts were not symmetrical.

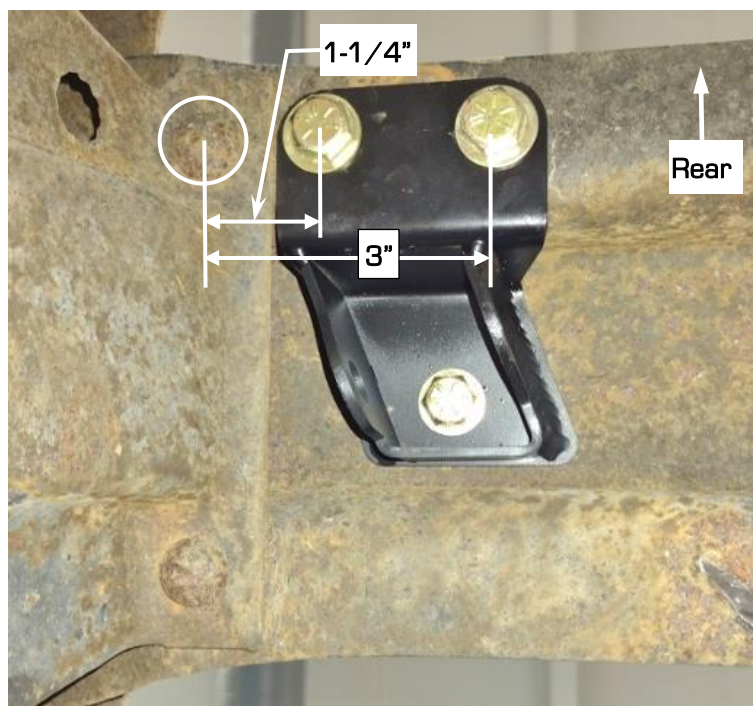

Figure 6 - Locate LH Upper Shock Mount

9. Clamp the upper shock mount in place and transfer punch all three holes to the crossmember. Remove the clamps and the hardware from the upper shock mounts and remove them from the crossmember. Drill the five marked holes into the crossmember to a final drill size of 13/32". **NOTE:** It is recommended that pilot holes be drilled first before drilling the 13/32" holes.

10. Install the upper shock mounts into the crossmember using the provided 3/8"-24 hardware. Use anti-seize on the threads of the bolts. Torque the 3/8"-24 hardware to 35 ft-lbs. (Figure 7).

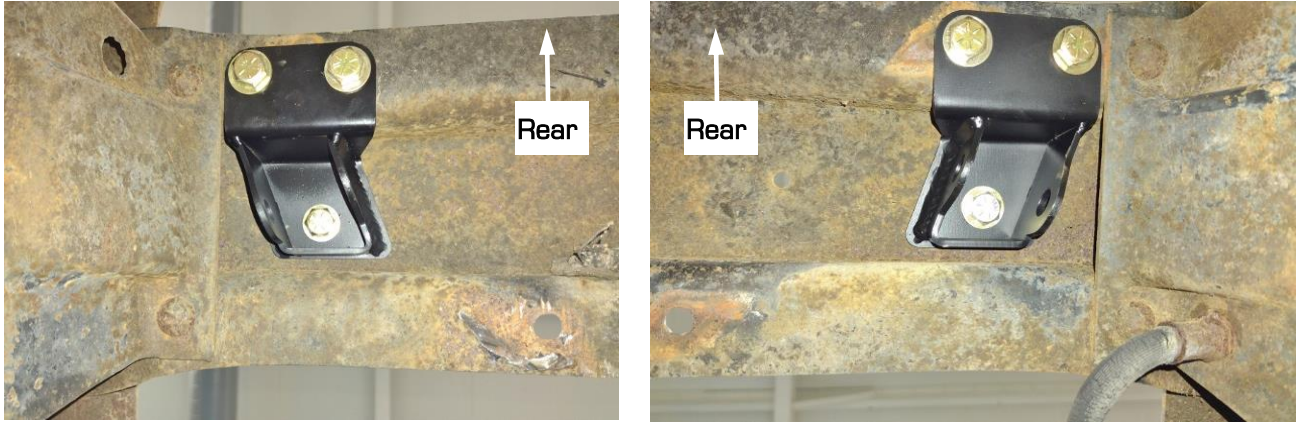

Figure 7 - Install Upper Shock Mounts

11. Slide the lower shock mount onto the inboard side of the left hand trailing arm until the U-bolt holes in the lower shock mount line up with the U-bolt holes in the trailing arm (Figure 8).

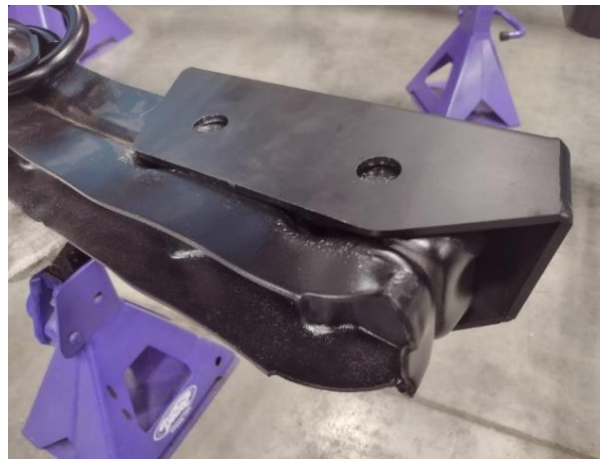

Figure 8 - Install Lower Shock Mount

12. Raise the trailing arm up so the U-bolt passes through the shock mount and trailing arm. Thread the U-bolt nuts and washers onto the U-bolts to keep the trailing arm in place (Figure 9). **NOTE:** Detroit Speed offers stock replacement U-bolts and hardware (PN: 040704DS). If you are also installing the DSE Anti-Squat Kit (PN: 040119DS), new U-bolts are included in this kit.



Figure 9 - Raise Trailing Arm

13. Locate the right hand track bar/lower shock mount. Slide the lower shock mount onto the inboard side of the right hand trailing arm until the U-bolt holes in the lower shock mount line up with the U-bolt holes in the trailing arm.
14. Raise the trailing arm up so the U-bolt passes through the track bar/shock mount and trailing arm. Thread the U-bolt nuts and washers onto the U-bolts to keep the trailing arm in place.
15. Tighten the U-bolts evenly on both sides of the truck (Figure 10). **NOTE:** The images below show the Detroit Speed Anti-Squat Kit with pinion angle spacers (PN: 040119DS).

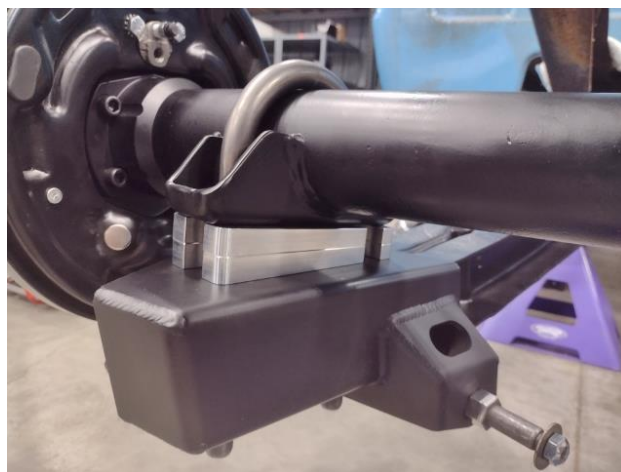

Figure 10 - Tighten U-Bolts

16. Position the provided drop shocks into the installed upper shock mounts. Install the provided 1/2"-13 x 2-1/4"L hex head bolts, washers and Nylock nuts through the upper shocks mounts and shock bushings. The bolts will need to be installed so the head of the bolt is on the inboard side of the truck (Figure 11).



Figure 11 - Install Shocks

17. Insert the provided shock studs into the lower shock mount bushings. Then, install the shock and stud into the lower shock mounts. Tighten the 5/8"-18 shock stud nut (mount side) to 120 ft-lbs. Tighten the 7/16"-20 stud (bushing side) to 40 ft-lbs.
18. Re-install the springs between the truck arm and chassis using the factory retainers and hardware. **NOTE:** The DSE Track Bar and Shock Mount Kit is designed for a minimum of 4" lowering springs. Any springs factory height to 4" drop will not allow for proper shock travel and will cause possible damage to the shocks.

19. Next, locate the track bar chassis bracket assembly on the driver's side of the frame rail. The four slotted holes on the bottom of the bracket will locate with three holes from where the factory track bar bracket was removed on the bottom side of the frame rail. You will mark and drill the 4th hole. If you have installed the DSE frame notch bracket kit, skip to **Step 22**.
20. Install the provided 7/16"-20 x 1-3/4" L hex head bolts, washers and Nylock nuts into the bottom side of the track bar bracket and through the frame rail to hold it in place.
21. **If you have not installed the DSE frame notch bracket kit**, transfer punch the bottom of the four slotted holes onto the side of the frame rail using the track bar bracket as a template.
22. Remove the track bar bracket assembly from the frame rail. Using a 15/32" drill bit, drill through the four marked holes on the outside of the frame rail. **NOTE:** It is recommended that pilot holes be drilled first before drilling the 15/32" holes.
23. Install the track bar bracket to the frame rail using the provided 7/16"-20 x 1-1/4" L hex head bolts, washers and Nylock nuts into the four holes on the side of the track bar bracket and frame rail. Install the provided 7/16"-20 x 1-3/4" L hex head bolts, washers and Nylock nuts into the four holes on the bottom side of the track bar bracket and frame rail (Figure 12). **NOTE:** Figure 12 has the DSE Frame Notch Bracket Kit installed.



Figure 12 - Install Track Bar Bracket

24. Next, install the DSE track bar using the provided M14-2.0 x 80mm hex head bolts. Install one of the M14 bolts through the chassis track bar bracket assembly and the track bar bushing. Install the other M14 bolt through the the track bar axle bracket and the track bar bushing. The middle hole in track bar chassis bracket and the top hole in the track bar axle bracket is the nominal setting for a lowered ride height (Figure 13). **NOTE:** The track bar should be as close to level as possible when at ride height. This is highly dependent on the desired ride height of the truck. You can use any combination of mounting holes to achieve a level track bar if your ride height is not adjustable.

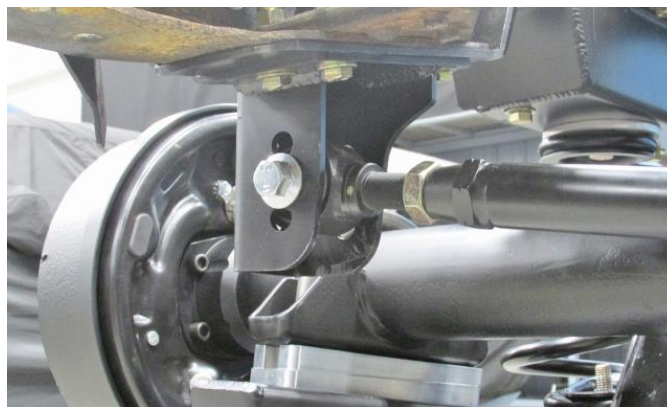
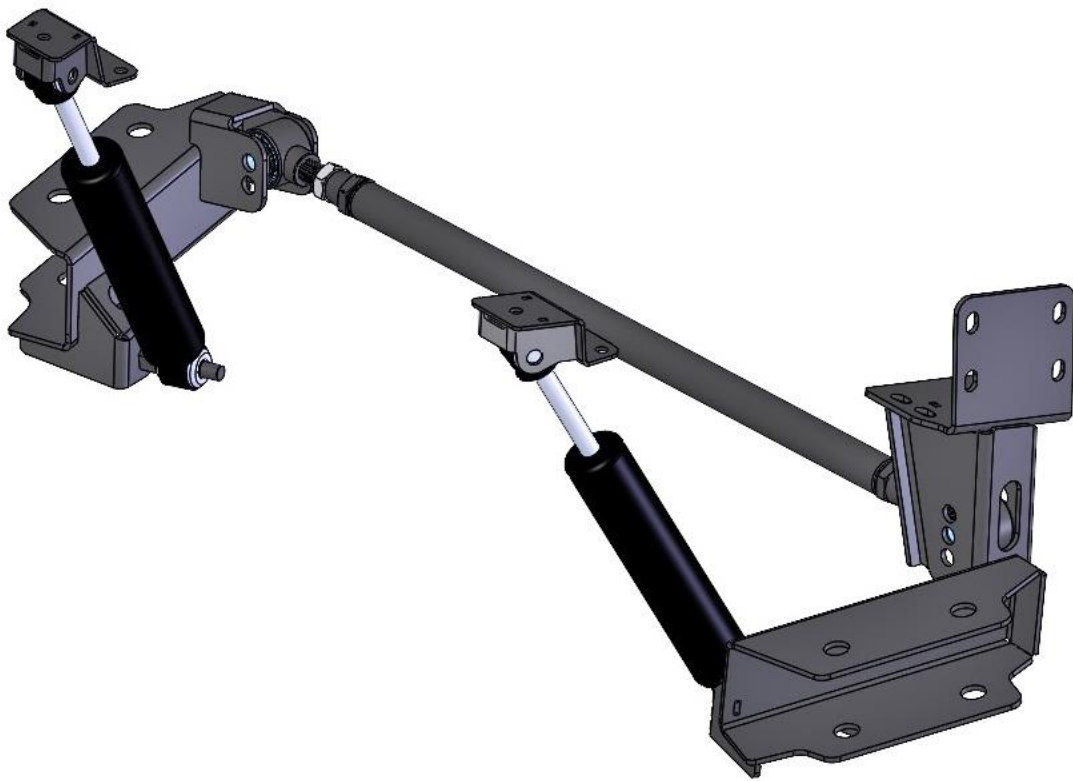

Figure 13 - Install Track Bar

25. Thread the provided M14-2.0 flange lock nuts on the end of the track bar bolts and tighten. Torque the fasteners to 120 ft-lbs.
26. Raise the rear axle with a floor jack so the weight of the truck is on the rear suspension. Verify that the track bar is parallel to the ground and does not interfere with the truck chassis and suspension.
27. Verify that the rear axle is centered in the truck. With the suspension loaded, measure the distance from the frame to a reference on the rear axle (brake drum or rotor). Adjust the length of the track bar until the measurement is equal on the left and right side. **NOTE: There can be no more than 2" of exposed threads on the end links (3/4" of thread engagement in the tube).** This measurement does not include the jam nut [see page 9].
28. Once the track bar has been adjusted, torque the jam nuts to 50 ft-lbs. Installation of the suspension is now complete.



If you have any questions before or during the installation of this product, please contact Detroit Speed at tech@detroitsspeed.com or 704.662.3272

Legal Disclaimer: Detroit Speed is not liable for personal, property, legal, or financial damages from the use or misuse of any product we sell. The purchaser is solely responsible for the safety and performance of these products. No warranty is expressed or implied.

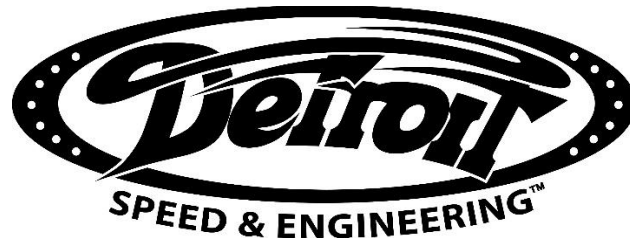

Detroit Speed
Track Bar End-Link

WARNING:

There can be no more than 2" of exposed threads on the end link (3/4" of thread engagement in the tube). This measurement does include the jam nut (see below).

